

7015-4P2T-T1L

Unmanaged 4 x 10BASE-T1L SPoE & 2 x 10/100 RJ45 Industrial SPoE Switch

Description

The IEEE 802.3cg Single Pair Ethernet (SPE) standard defines Ethernet operation over a single twisted wire pair for industrial control networks. It enables 10Mbps Ethernet communications over existing fieldbus cables up to 1000m, significantly longer than standard 100BASE-TX.

Our unmanaged SPE switch extends this capability by incorporating Single-pair Power over Ethernet (SPoE) technology, supporting power classes 10-12 with 24V delivery or power classes 13-14 with 55V delivery to powered devices. This combination provides both data connectivity and substantial power delivery over the same single pair infrastructure.

By running Ethernet and power over existing fieldbus wiring, our SPE switch with SPoE significantly simplifies cabling and reduces costs. It expands Industrial Ethernet to new sensor, actuator and automation applications requiring both low speed connectivity and power delivery without additional wiring. This solution enables convergence of industrial automation systems over Ethernet while interoperating with existing Ethernet networks over standard CAT5/6 cabling.



RoHS
CE FC

Features Highlight

SPE Switches with SPoE technology are designed to deliver both Ethernet data transmission and flexible power to a diverse range of industrial, building automation, transportation, IoT, and edge computing devices. With data and power combined in a single cable, SPE switches simplify cabling, reduce costs, and increase application flexibility. Key application domains include:

Industrial Automation

Supporting a full spectrum of field devices including sensor networks (temperature, humidity, pressure, and flow), actuators, flowmeters, pressure transmitters, small motors, and both low- and medium-power remote I/O modules.

Building Automation

Powering and connecting LED lighting drivers, dimming controllers, occupancy sensors, door contacts, card readers, electronic locks, access control panels, and a variety of advanced security and surveillance devices, including IP and PTZ cameras.

Traffic Infrastructure

Enabling traffic signals, roadside sensors, environmental monitoring, traffic controllers, small information displays, and digital signage—all through single-cable connectivity.

IoT and Edge Devices

Supporting environmental monitors, asset trackers, edge gateways, local data processing nodes, and a variety of HVAC controllers and security sensors, scaling from simple endpoint monitoring to higher-compute edge nodes.

Industrial Control Networks

Integrating with standardized industrial protocols (e.g., PROFINET, EtherNet/IP) at the field level, facilitating simultaneous data and power transmission for distributed sensors, actuators, and remote I/O modules.

Applications

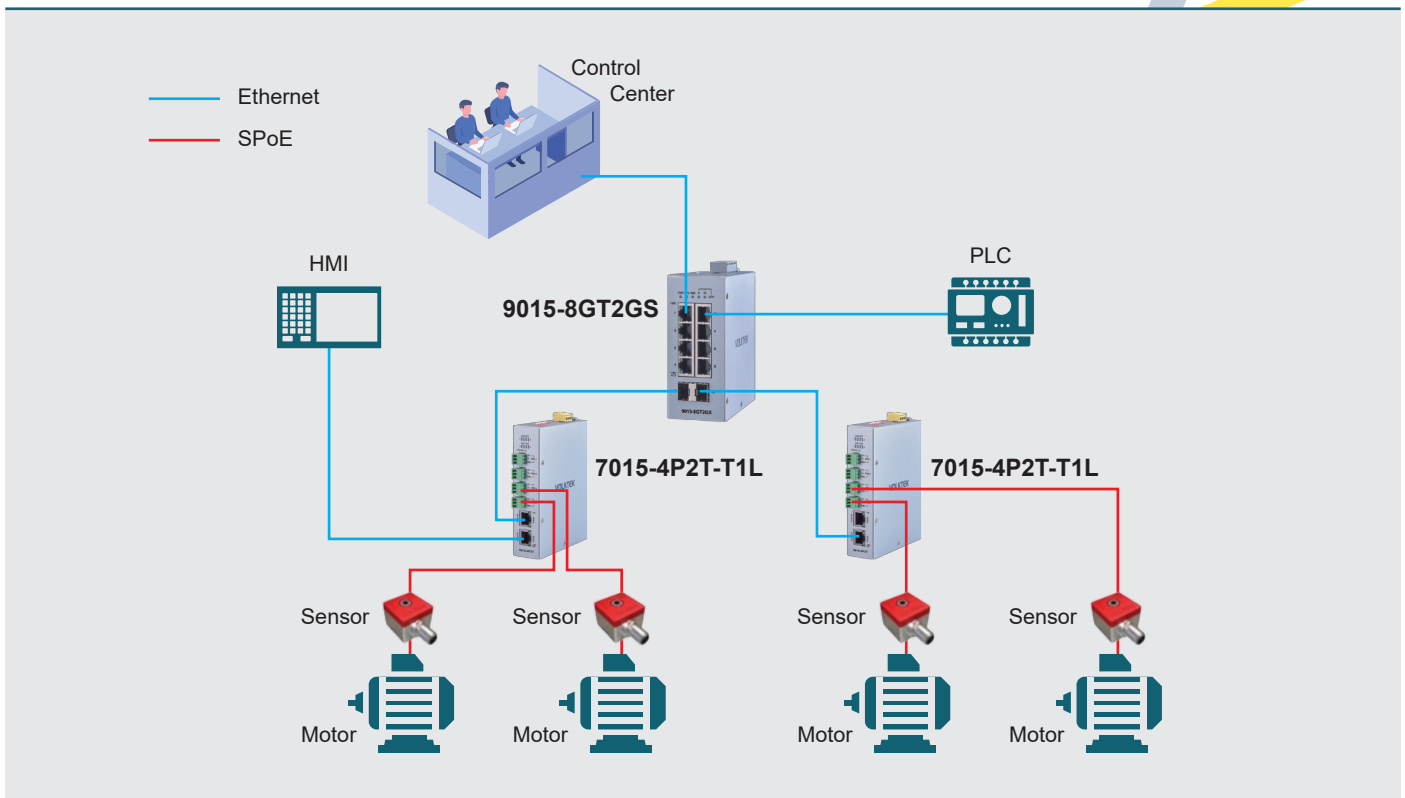

Specifications

Standards	
IEEE 802.3	10BASE-T
IEEE 802.3cg	10BASE-T1L (Compliant)
IEEE 802.3u	100BASE-TX
IEEE 802.3	Nway Auto-negotiation
IEEE 802.3x	Flow Control
Interface	
Ports	2 x 10/100 RJ45 Port 4 x 10BASE-T1L SPoE Port
DIP Switch	1 x SPoE Functionality 1 x SPoE Class Selection 4 x Auto/Manual Mode 4 x Master/Slave Role
LED Panel	PWR, 100, LNK/ACT, SPoE
Features	
Performance	MAC Table Entries: 1K Switching Fabric: 480Mbps Packet buffer: 512Mbit Forwarding Rate: 357.14Kpps
Power	
Input Voltage	20-30 VDC (Class10-12) 50-58 VDC (Class13-14)
Power Consumption	4W (System Only)
SPoE Power Budget	132W
Max. Power Per Port	24V: 14W, 55V: 33W
Mechanical and Environment	
Housing	Metal (IP40 Protection)
Operating Temperature	-40°C~70°C (-40°F~158°F)
Storage Temperature	-40°C~85°C (-40°F~185°F)
Operating Humidity	5~95% RH (non-condensing)
Storage Humidity	5~95% RH (non-condensing)
Weight	525 g (1.16 lb)
Dimension (WxHxD)	31 x 136 x 105 mm (1.22 x 5.36 x 4.13 in)

Certifications	
Electromagnetic Compatibility	FCC Part 15 Subpart B Class A
	EN 55032 / UKCA Class A
	CISPR 32 Class A
	EN 55011 / UKCA Class A
	CISPR 11 Class A
	EN 61000-6-4 / UKCA
	ICES-003 Issue 7
	EN55035 / UKCA
	EN 61000-6-2 / UKCA
	EN 61000-4-2 (ESD)
	EN 61000-4-3 (RS)
	EN 61000-4-4 (EFT)
EN 61000-4-5 (Surge)	
EN 61000-4-6 (CS)	
IEC 61000-4-8 (PFMF)	
Shock Test	IEC 69968-2-27
Freefall Test	IEC 60068-2-31
Vibration	IEC 60068-2-6
Ordering Information	
7015-4P2T-T1L	Unmanaged 4 x 10BASE-T1L SPoE & 2 x 10/100 RJ45 Industrial SPoE Switch
7015-4U2T-T1L	Unmanaged 4 x 10BASE-T1L SPE & 2 x 10/100 RJ45 Industrial SPE Switch

Note:

* Specifications subject to change without notice.

Dimension

