

# VOLKTEK

## INS-8224P

### Unmanaged 4 x 10/100/1000 RJ45 & 2 x GbE SFP Switch

#### Description

INS-8224P, a new addition to Volktek's Unmanaged Gigabit PoE switch, is engineered with industrial grade components to maintain a highly reliable network for 24/7 outdoor surveillance. Although unmanaged, the switch builds with well-protected IP30 metal housing, sufficient rugged features and can withstand in harsh temperature ranging from -10°C to 60°C.

The switch supports PoE+ (IEEE 802.3af/at) on 4-Gigabit copper ports to fulfill the demands of transmitting voice, video, data over a single network cable with per port 30W power budget. The 2-Gigabit fiber slots give advantages of configuring daisy chain topologies offering full-proof fiber for a safe, reliable and long distance Gigabit connectivity. Designed with these beneficial features, the switch proves to be a robust and high performable solution, enabling a consistent network even in harsh environments for outdoor surveillance.

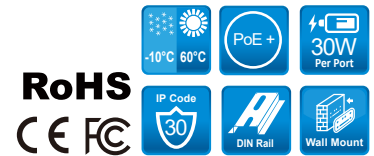
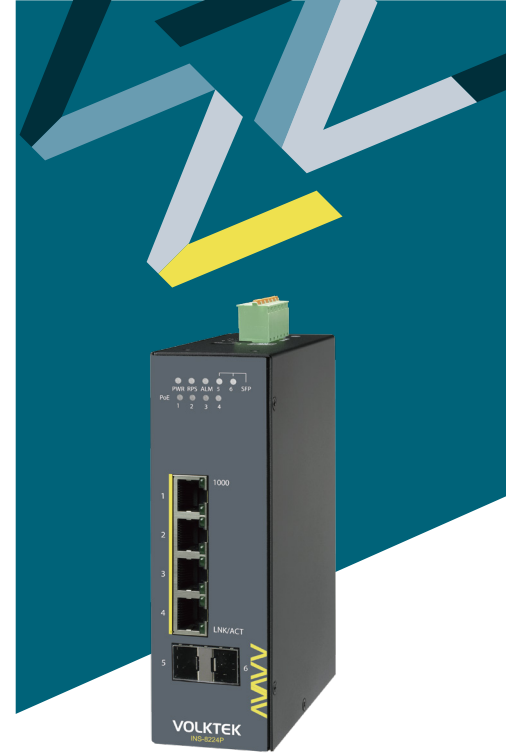

#### Features Highlight

##### Robust Performance and Protection

Enclosed with a rugged IP30 hardened metal housing, the switch can able to sustain harsh temperatures ranging between -10°C~60°C. Along with this, the INS-8224P is built with various protection features such as ESD Protection, Surge Protection, Reverse Polarity Protection and Short Circuit Protection to ensure continuous operation of mission-critical applications even in unstable power conditions.



##### High-Power Budget for PoE Network Devices

INS-8224P is capable of delivering power up to 30W per port (IEEE 802.3af/at) PoE+ compliant powered devices. Thereby, irrespective of their location, powered devices can be powered without installing additional power outlets or cabling and significantly reduce your CAPEX.

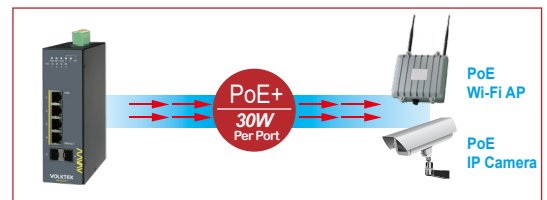

##### Future-proof Fiber Connectivity with Dual SFP Ports

With dual Gigabit fiber slots, the INS-8224P can easily established fiber channel for Gigabit Ethernet connectivity and allows you to take advantage of fiber based daisy chain topologies. The switch provides long distance, high-speed fiber connectivity while offering enhanced noise immunity and data security across deployed systems. That makes INS-8224P be a well-suited robust, cost-effective and future-proof solution for fiber based surveillance networks.

##### DIN-Rail-mounted Power Adapter (AC to DC)

The INS-8224P is combined with "DIN-Rail Power Adapter" which functions as primary power source that converts AC to DC for board operation in an easy and firm installation with hardened connection. Saving your time and space, this adapter can be easily DIN-Rail-mounted next to INS-8224P in surveillance applications that have little space available.

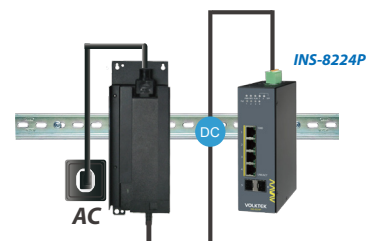

## Features Highlight

### Redundant Power Supply

Considering the power failure impact in surveillance applications, INS-8224P is developed with standard "6-pin Terminal Block" for redundant power to provide continuous service resulting reliable and consistent network. In addition, the switch is equipped with alarm feature to notify the occurrence of power failure, helps in quick respond and faster trouble shooting.

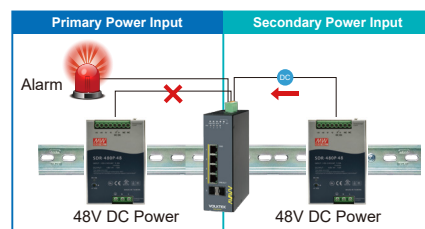

## Applications

### Cost-saving Fiber Connectivity

INS-8224P is configured with dual Gigabit SFP ports which can easily make daisy chain topologies to power more number of PoE+ enable power devices as well as saves the amount of fiber cabling connecting to the control room. Due to daisy chain architecture only a single fiber connects to the control room which in turn saves CAPEX.

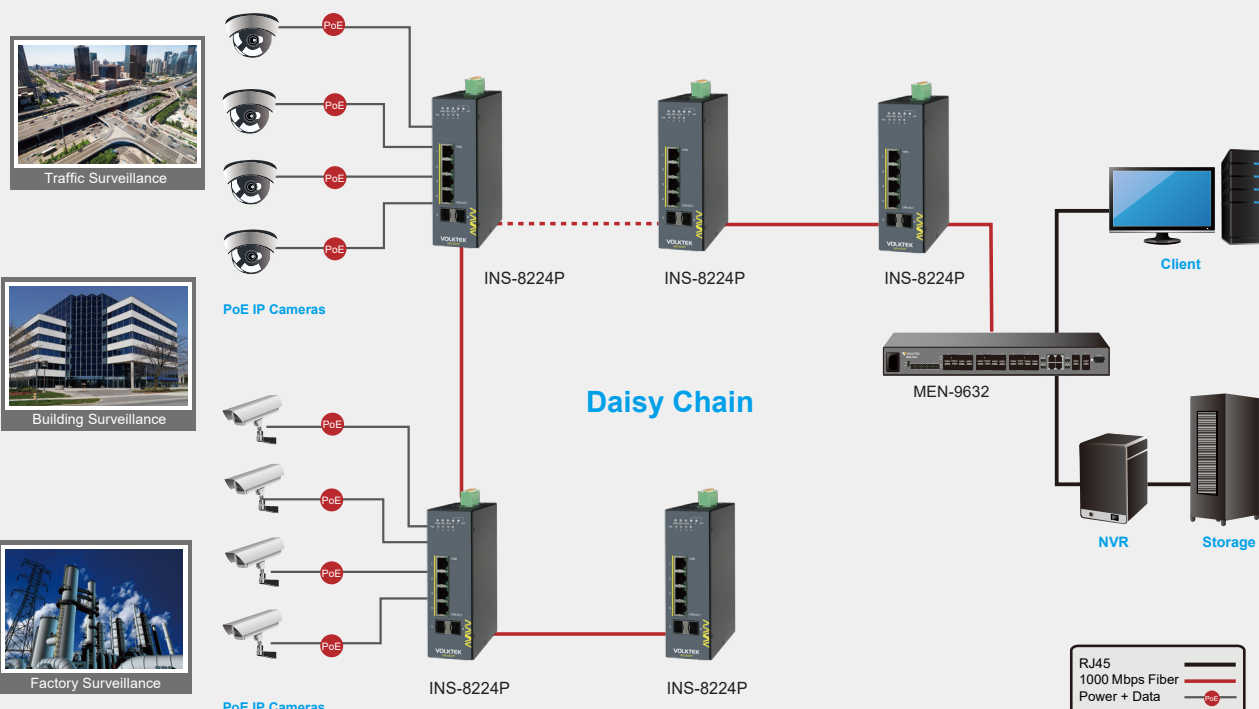

### Scalable Ethernet plus Easy Fiber Extension to Control Room

The INS-8224P guarantees a strong, stable connection of Ethernet, Fast Ethernet or Gigabit Ethernet, providing flexible deployment options to satisfy industrial networking requirements. Addition to this, the switch can be easily extended to control center with hassle-free fiber to enable a full-proof and complete surveillance.

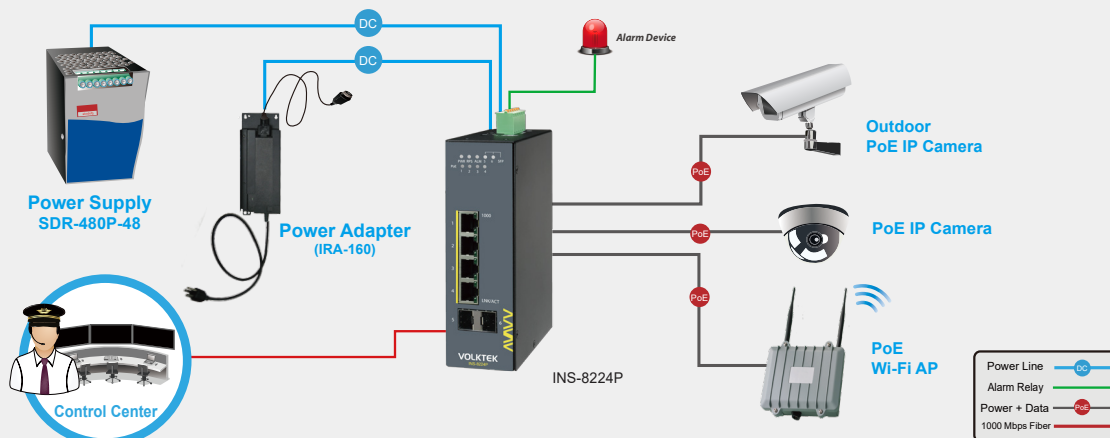

## Specifications

Standards	
IEEE 802.3	10BASE-T
IEEE 802.3u	100BASE-TX
IEEE 802.3ab	1000BASE-T
IEEE 802.3z	1000BASE-SX/LX
IEEE 802.3	Nway Auto-negotiation
IEEE 802.3x	Flow Control
IEEE 802.3af	Power over Ethernet
IEEE 802.3at	Power over Ethernet Plus
IEEE 802.1p	Class of Service
Interface	
Ports	4 x 10/100/1000BASE-T (PoE RJ45) 2 x GbE SFP Slots
DIP Switch	Primary/Redundant Power Voltage Drop Alarm setting
LED Panel	PWR, RPS, ALM, SFP, PoE, 1000, LNK/ACT
Features	
Performance	Throughput: 14,880 pps to 10 Mbps ports
	148,800 pps to 100 Mbps ports
	1,488,000 pps to 1000 Mbps ports
	MAC table size: 8K
Functions	Switch fabric: 12Gbps
	Jumbo Frame size: 10KBytes
	VLAN Passthru
PoE+ Functions	Up to 4 IEEE 802.3at powered devices
	Supports PoE Power up to 30W for each PoE port
	Auto detect powered device (PD) Remote Power Feeding up to 100m
Power	
Input Voltage	Primary inputs: 48~57V DC
	Redundant inputs: 48~57V DC
Connection	Terminal Block, Mini-DIN
Power Consumption	System: 10W PoE Power Budget: 120W
Alarm Relay	One relay output, 1A @ 24V DC

**Note :**

\* The SFP communication distance upon the request.

\* Industrial SFP with wide operating temperature from -40°C~85°C (-40°F~185°F) is available upon request.

\* Specifications subject to change without notice.

Mechanical and Environment	
Housing	Aluminum (IP30 Protection)
Mounting	DIN-Rail
Operating Temperature	-10°C~60°C (14°F~140°F)
Storage Temperature	-40°C~85°C (-40°F~185°F)
Operating Humidity	5 to 95% RH (non-condensing)
Storage Humidity	5 to 95% RH (non-condensing)
Weight	705 g (1.6 lb)
Dimension (WxHxD)	50 x 160 x 120 mm (1.97 x 6.3 x 4.72 in)
Certifications	
EMI	FCC Part 15 Subpart B Class A
	EN 55022: class A
	EN 55011: 2009 class A
	EN 61000-6-4
EMS	EN 55024
	EN 61000-6-2
	EN 61000-4-2 (ESD)
	EN 61000-4-3 (RS)
	EN 61000-4-4 (Burst)
	EN 61000-4-5 (Surge)
Shock	EN 61000-4-6 (CS)
	IEC 60068-2-27
Freefall	IEC 60068-2-32
Vibration	IEC 60068-2-6
Ordering Information	
INS-8224P	Unmanaged 4 x 10/100/1000 PoE+ & 2 x GbE SFP
Optional Accessories	
Power Supply	SDR-480P-48: 480W DIN-Rail 48V DC Industrial Power Supply, -25°C~70°C (-13°F~158°F)
GBM-104	1000BASE-SX 1.25G, Multi-mode SFP, 500m
GBM-123TS	1000BASE-LX, Bi-Di SFP TX:1310/RX:1550 Single Mode, 10Km, 0°C~70°C (32°F~158°F)
GBM-123RS	1000BASE-LX, Bi-Di SFP TX:1550/RX:1310 Single Mode, 10Km, 0°C~70°C (32°F~158°F)

## Dimension

